

平面図

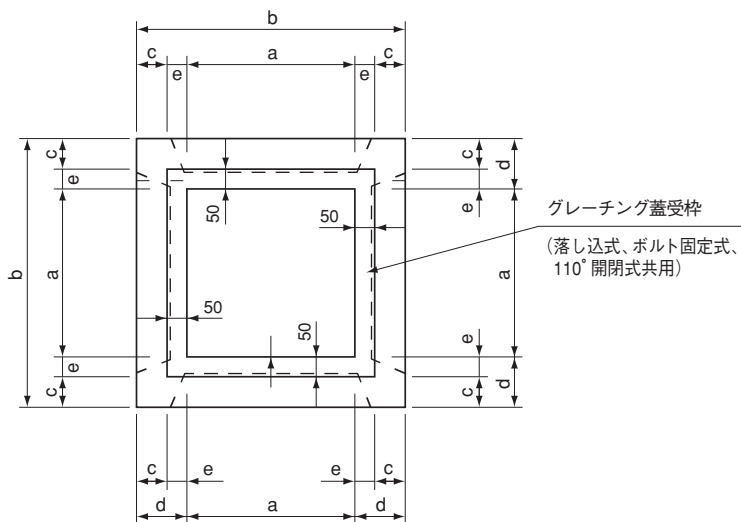

側面図

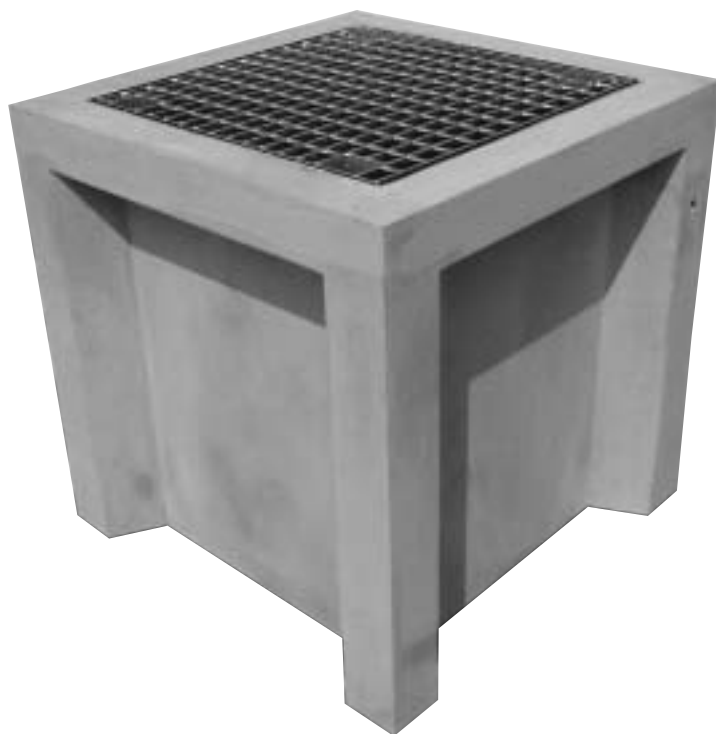
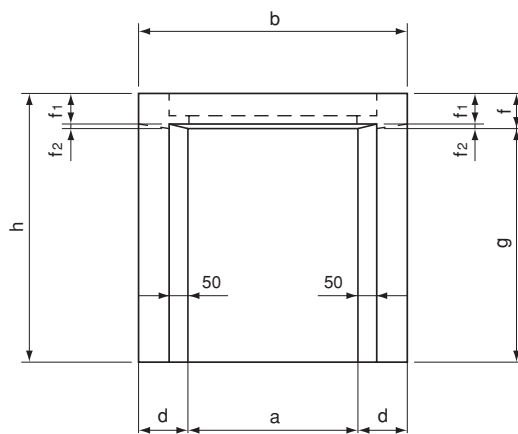

■ プレセット柵

呼び名	寸法 (mm)										参考重量 (kg)	備考
	a	b	c	d	e	f	f1	f2	g	h		
プレセット柵	500	800	100	150	50	100	90	10	700	800	359	
	500	800	100	150	50	100	90	10	700	1000	441	
	500	800	100	150	50	100	90	10	700	1200	522	

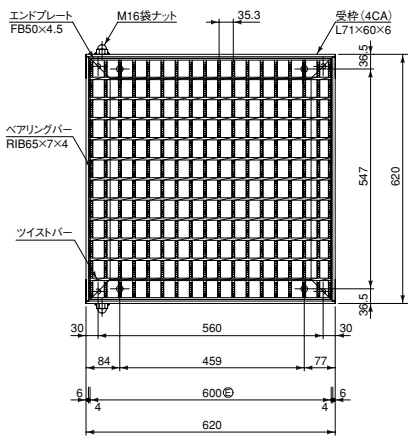

粗目落とし込み

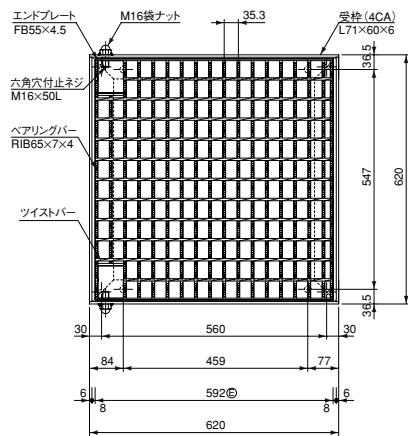

粗目110°開閉

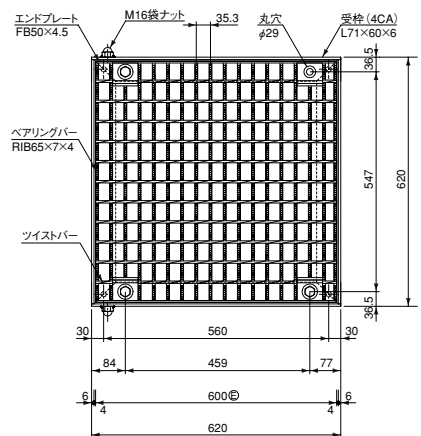

粗目ボルト固定

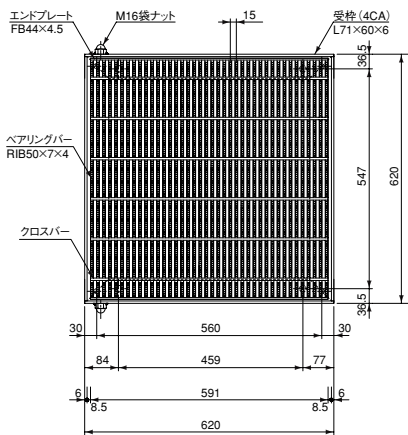

細目落とし込み

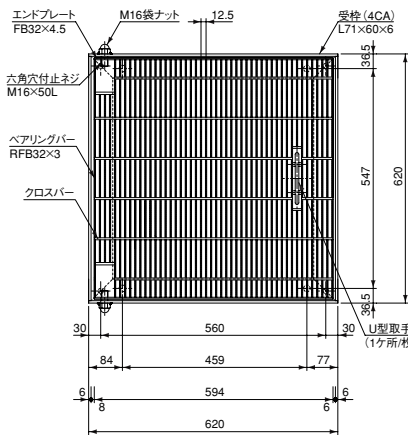

細目110°開閉

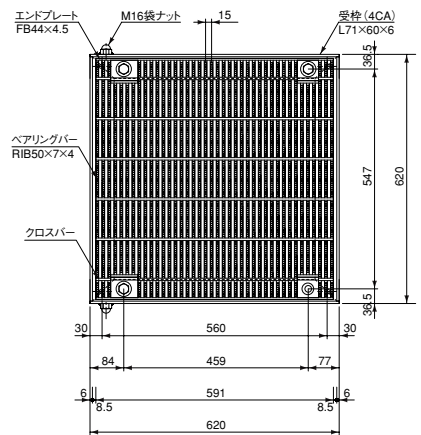

細目ボルト固定

■ プレセット柵用グレーチング

呼び名	寸法(mm)	荷重	備考
500用	500×500	T-2	
		T-6	
		T-14	
		T-20	
		T-25	